

ISSUE # 127
WINTER 2011

INDOOR

NEWS and VIEWS

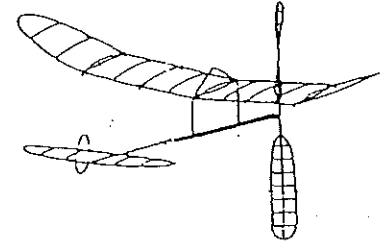

FROM THE EDITOR'S DESK

A BELATED HAPPY NEW YEAR 2011 !!!!!

The New Year is here and it's time to make those resolutions on things we should do for ourselves, like build new and better models, go to more contests and help other people. With that piece of advice, I have a request from me to all of you. I need more input from you, our subscribers. Plans, scores from recent contests, upcoming contests, you name and if it's indoors and free flight I'll use it, send it to me. I may not use it in the latest INAV, but I'll use it sooner or later. Check the picture of the roof of the Cardington Air Shed, that's an old one, but ever current. Some of you modelers have fond memories of that site and it's of no use to us now. Enough of that stuff, let's see what we have for you in this issue. From Akihiro Danjo we have two great items. One is his record setting F1M the other is another record setter and it's a discus hand launched glider. There's a lot more thought and effort goes into these models and present more of a challenge than the older type. Try it, you'll like it. We also have a Ministick for you and this is an excellent one for low ceilings and will do well in the Postal Contest that started on the 1st of January. Hint. This model was designed by Walt Collins and has place numerous times in the Postal Contests. More hints. To round out the plans there is an A-6 by John Lenderman, this is not a beginners A-6. A lot of thought has gone into this model also, so weigh your wood and use the best to stay under weight. Next month we'll have another record setter a Limited Pennyplane by Tom Icobellis. Stay tuned.

DAVID S HAGEN

I just received word that subscriber David S Hagen passed away last year in Gresham, Oregon. David's daughter Jennifer was nice enough to inform of me of this and asked if his passing could be put in the Indoor News and Views so as to inform all his friends. Any one that would like to contact Jennifer reference David's upcoming Celebration of Life may contact her at E-mail 2.jen.r.ous@gmail.com.



AIR CONDITIONING FOR CARDINGTON

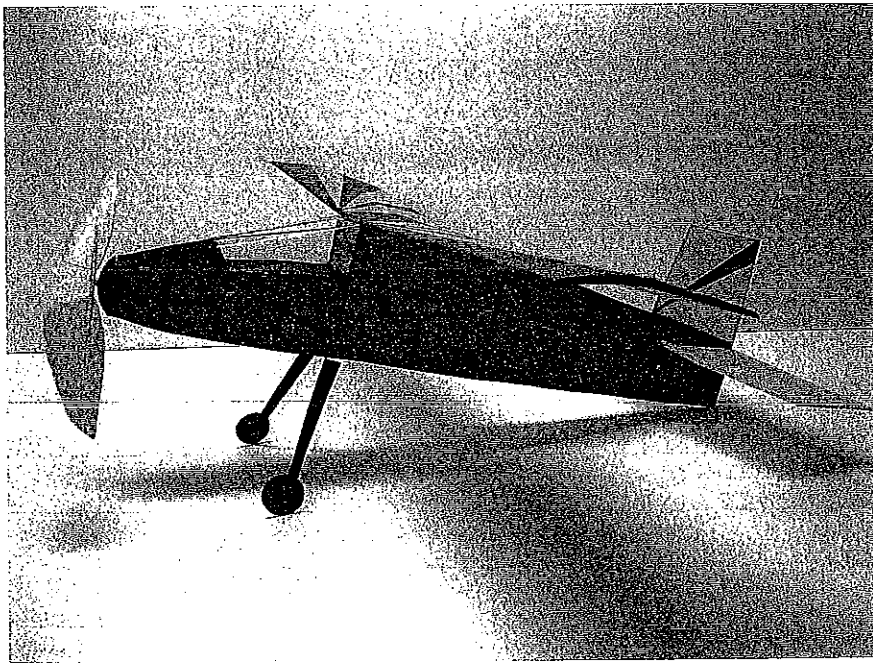

BOSTONIAN BY PAUL GRABSKI

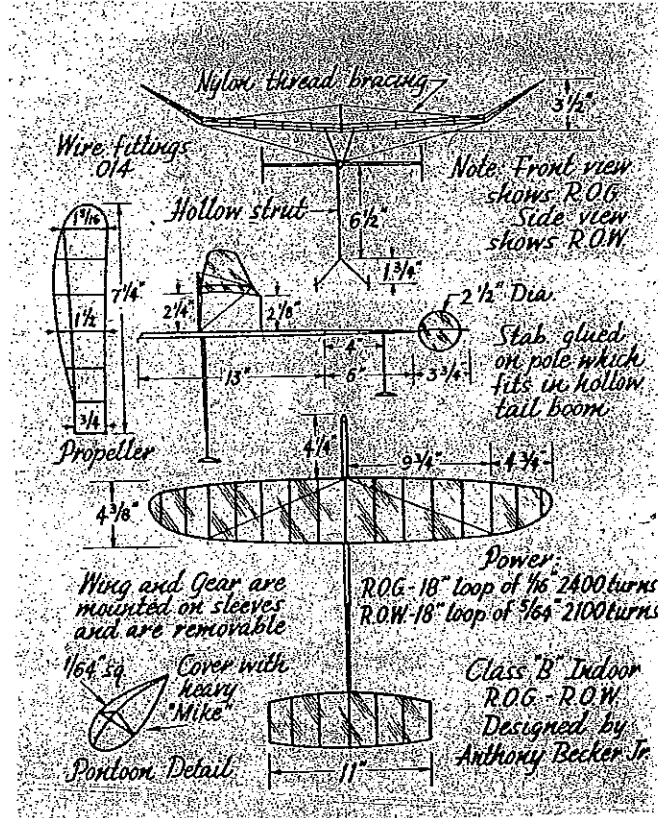
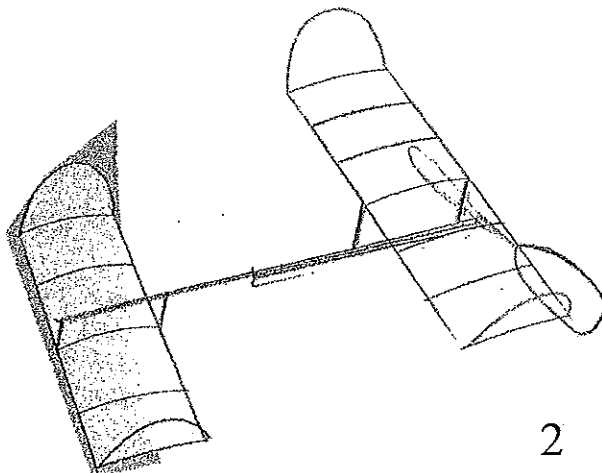

That indoor microfilm model

is "Tony" Becker's original creation which set an R.O.G. mark of 22:22.5 and a rise-off-water record nearly as high—18:51.6. And for awhile it held the stick h. l. time of 24:16!

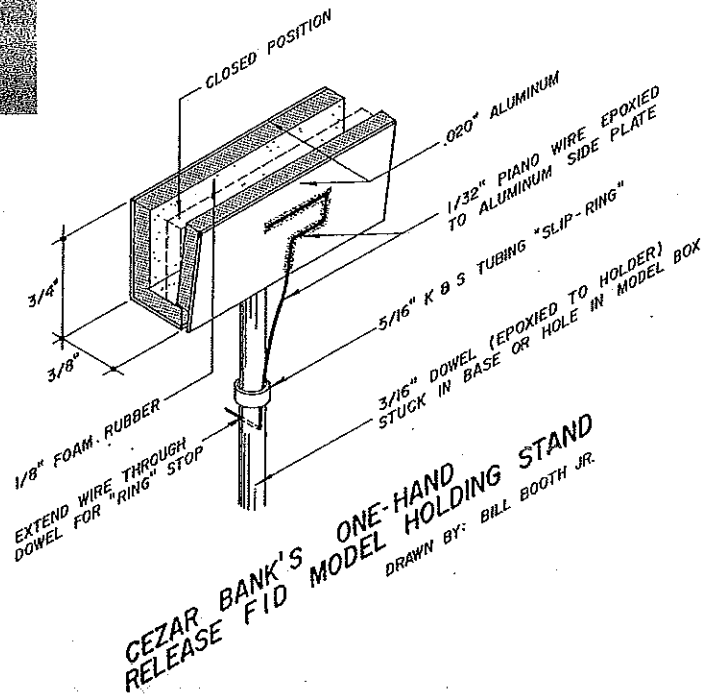

The Magnificent Mountain Men Proudly Bring You 5th Pikes Peak Ceiling Climb

Indoor Model Airplane Contest

Sunday, February 27, 2011

ANA Sanctioned Class AA

Flying site is the historic Colorado Springs City Auditorium, downtown,
corner of Weber and Kiowa Streets – 37 foot (peak) smooth ceiling

Flying Hours: 8:00 a.m. to 8:00 p.m.

Practice & fun flying during the contest is permitted but official flights
always have right-of-way. *Please exercise courtesy and common sense.*

Schedule (subject to change per demand for airspace)

8:00 a.m. – 12:00 p.m. GLIDERS ONLY
Hand Launched Glider, Unlimited Catapult Glider, Standard Catapult Glider, Absolutely no glider flying after 12:00 PM.

12:00 p.m. – 4:00 p.m. HEAVYWEIGHTS (models heavier than 2 grams, and LIGHTWEIGHTS *at your own risk*)
FAC Peanut Scale, FAC No-Cal Scale, P-24, Limited Pennyplane, Open Pennyplane/F1M combined, WWII No-Cal combat, Junior Rubber

2:00 p.m. WWII No-cal combat! All FAC rules apply plus 7" max prop diameter and minimum empty weight of 6.2 grams. Models must have correct color and markings and must have armament. Combat aircraft only. At least two rounds of flying.

5:00 p.m. Back by popular demand: pizza party in the Aud. \$5 per person all-you-can-eat does not include drinks (soda machine on site).

4:00 p.m. – 8:00 p.m. LIGHTWEIGHTS ONLY (models not more than 2 grams)
FIL, Easy B, Ministick, A-6, F1D

**Any indoor rubber powered model; Juniors only (15 and under)

The Fine Print:

- Contest director: Don DeLoach, ddeloach@comcast.net 719-964-7117.
- Link to AMA rules: <http://www.modelaircraft.org/templates/ama/POF-files/Rulebook/indorff.pdf>.
- Link to FAC rules: <http://www.theplanpage.com/things/FAC%20Rules%202005.pdf>.
- Link to NFFS National Cup rules: <http://www.freeflight.org/competition/IndoorNationalCup/info.htm>
- Entry fee: Open: \$20 - unlimited events. Junior/Senior: \$5 - unlimited events.
- "Colorado Cup" Grand Champ Trophy to highest scorer in up to 5 pre-selected events (at least 1 of the 5 must be a glider event, otherwise you may choose only 4 rubber events). 5-4-3-2-1 points for 1st, 2nd, 3rd, 4th, 5th place; 1 point deducted for each person fewer than 5 in an event.
- AWARDS: contest balsa, kits, other FF supplies
- Tables and chairs provided on site.
- Nearby Hotels: Clarion Inn (1/4 mile) 719-471-8680; Econolodge (1/2 mile) 719-636-3385.
- Sorry, no RC flying.

TOWER

005-008

TANK II

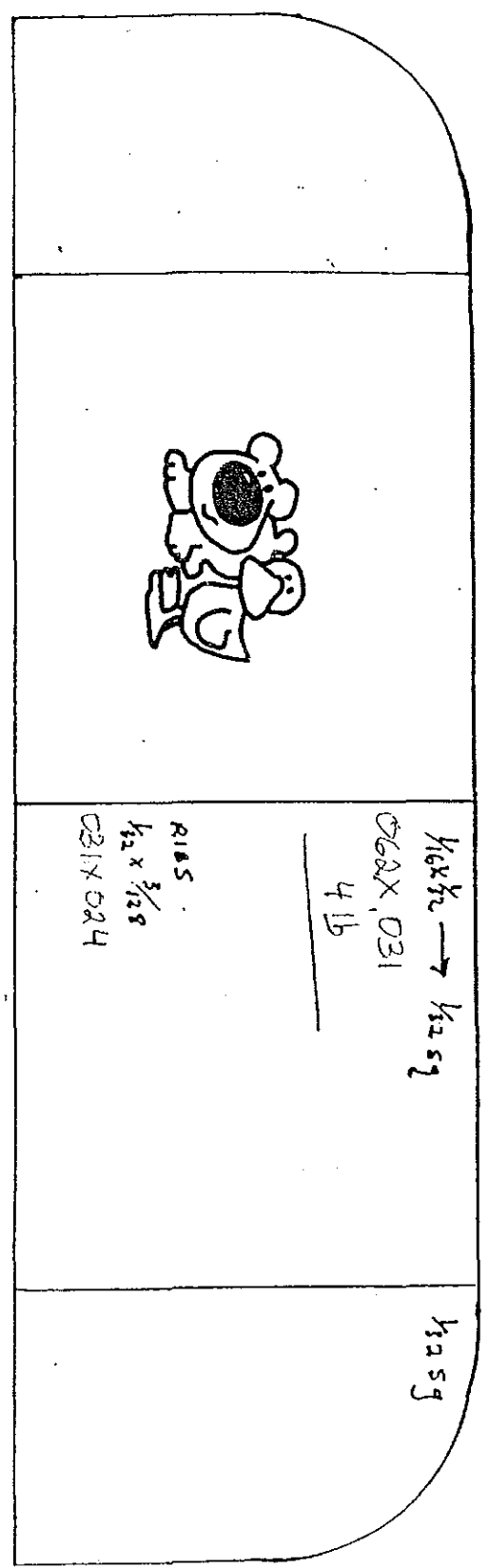

WALTS

MIMI

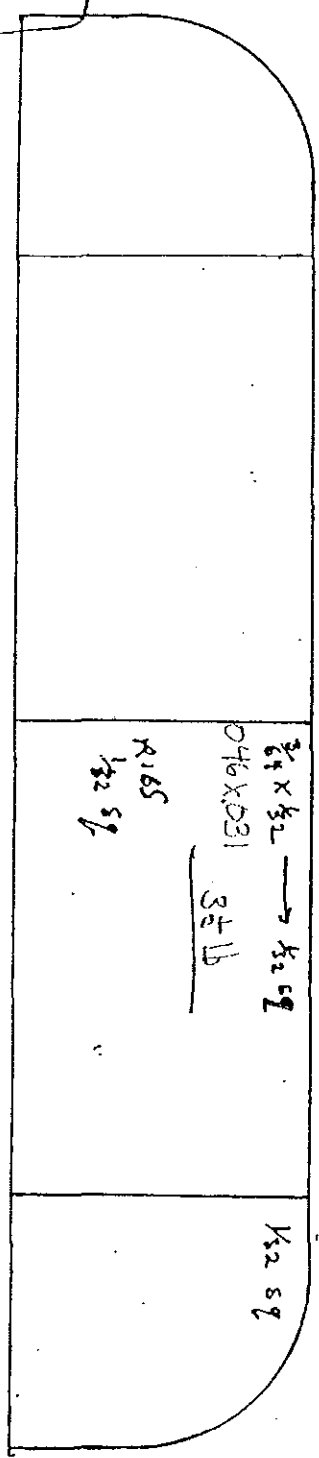

ALL WOOD APPROX 4 lb except Prop
Shaft which is 6 lb/cu ft

PWR: 10.5" Loop
.40g

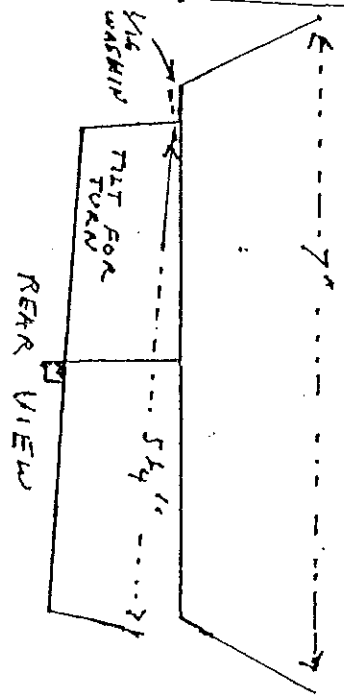
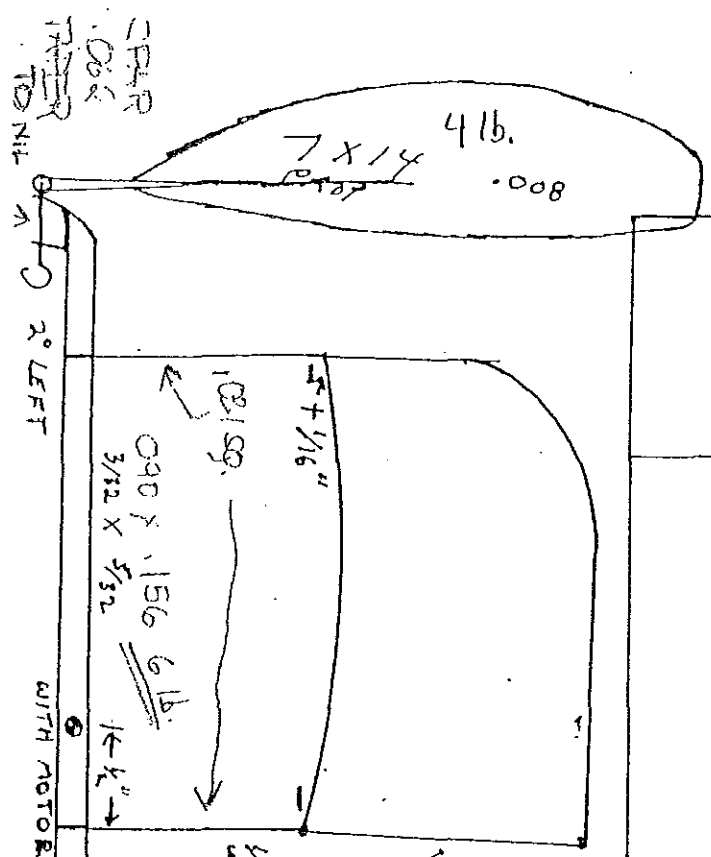

021 with 4/97

FIM CAT 1.2 & 3 WORLD RECORD

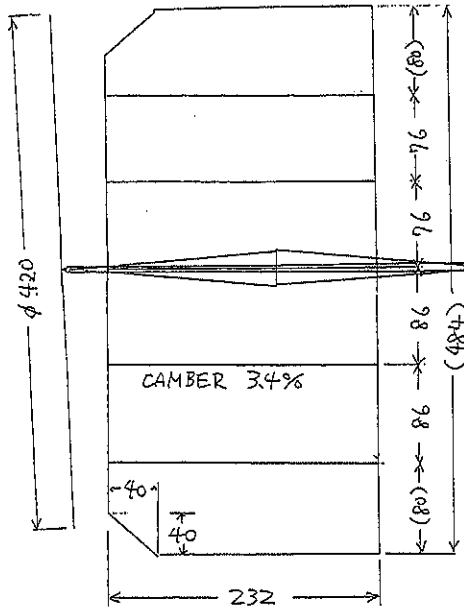

| WEIGHT | |
|--------------|---------------|
| PROP. | 483 |
| WING | 673 |
| M.S. | 884 |
| T.B. | 296 |
| STAB. | 421 |
| TAIL | 244 |
| TOTAL | 3001 g |

@ CAT 2 RECORD TRIAL

COVERING: PPP FILM (0.7/-)

SCALE 1/4 (EXCEPT PROP)

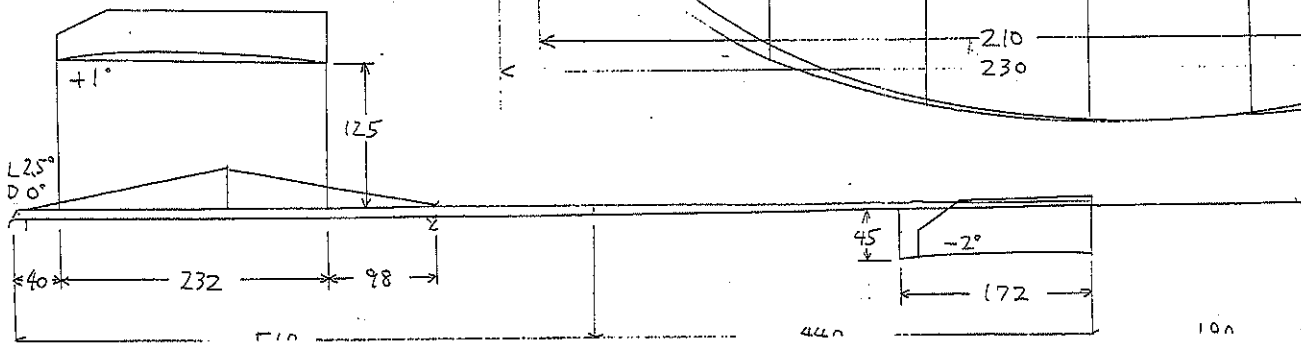
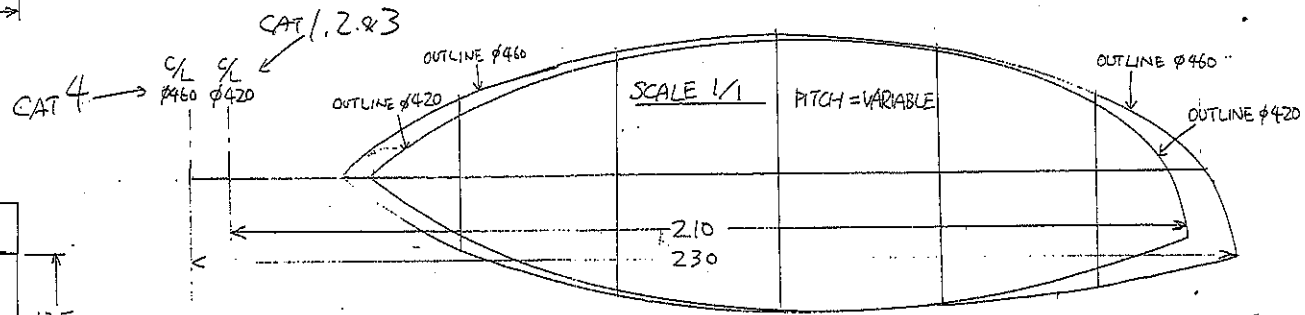
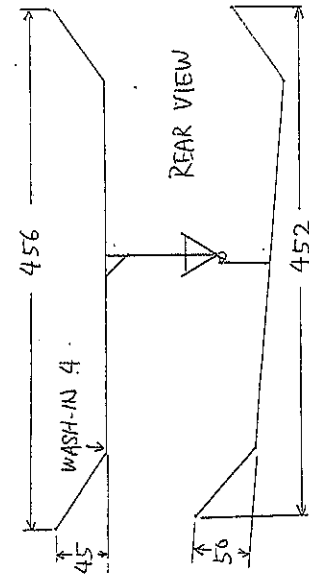
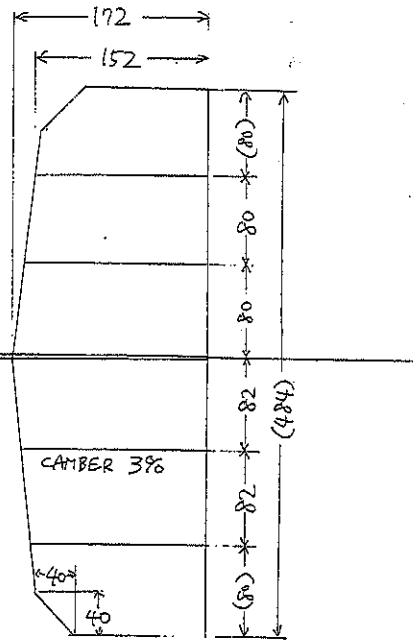

5

Akihiro Danjo's Parts & Size List

FIM-4 MATERIALS

WING MAIN SPARS #5.2 .137 x 2.4 ~ 1.7

TIP SPARS #5.5 1.3 x 1.5 ~ 1.2

RIBS COMP(2) #4.6 0.94 x 1.0
 " " 0.94 x 1.1

NORM(3) #4.6 0.94 x 1.8

TIPS #5.7 1.2 x 1.3

TAIL MAIN SPARS #4.7 1.45 x 2.2 ~ 1.5

TIP SPARS #5.5 1.3 x 1.3

RIBS #4.6 0.94 x 1.5

TIPS #5.0 1.0 x 1.3

STICK STICK #4.5 0.67 x 2.7
 BORON .003" @ 2 & 10 o'clock
 .004" @ 5 & 7 o'clock

TAIL #4.6 0.35 x 2.7 ~ 1.5
 BORON .003" @ 0 & 6 o'clock l=220

WING POSTS #9.2 1.25 x 2.5
 BORON .004" @ SIDE

PROP SPAR #8 2.0 x 2.0 ~ 1.0 x 1.0

OUTLINE #7 0.8 x 0.8



Bill Carney

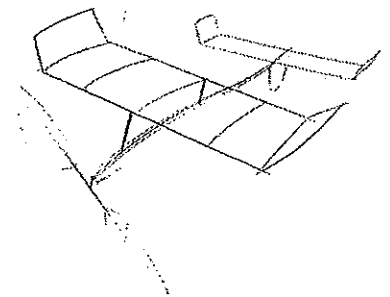
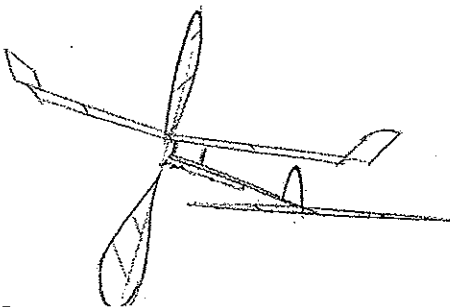

Wanted !!! Bill Carney. Bill, please contact me about missing Florida personnel from the AMA Indoor NATS in Johnson City, TN. We miss all you guys and gals Contact me at vandover@cox.net

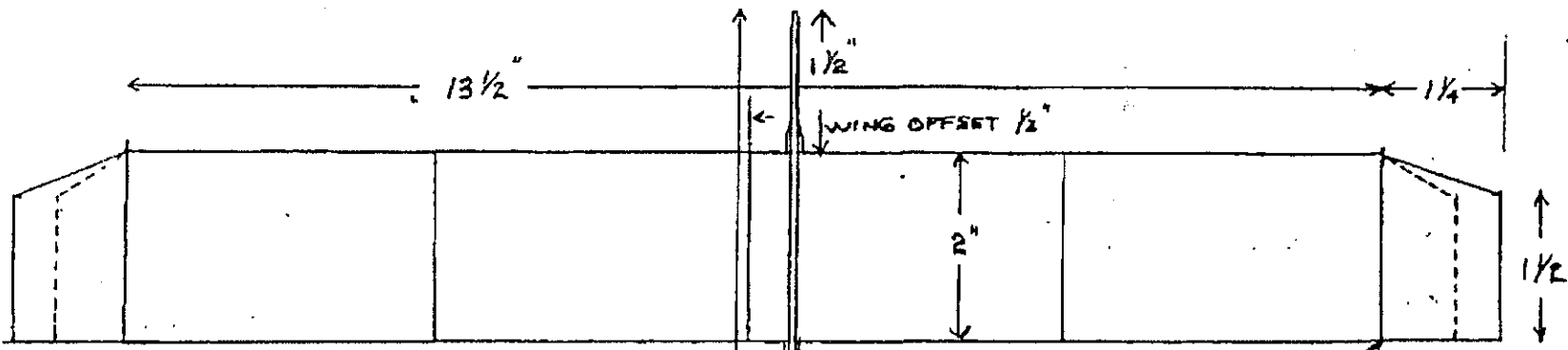

MODEL WEIGHT 1.8 GRAMS
RUBBER SIZE .033 X 12"

DIHEDRAL
1/4" EACH PANEL

RAISE TIPS TO
MAKE 15" SPAN
COVER TIPS
AFTER RAISING

ALL STRIPS 1/16" SQUARE

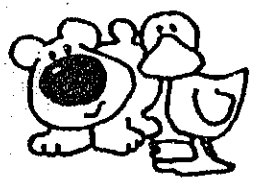

1/16" SQUARE STRIPS - GLUE
TO WING - HOLD WING
WITH ORTHODONIC
BANDS - ALA ARONSTEIN



BOOM SHOULD HAVE
2° NEGATIVE
INCIDENCE

.015 WIRE
PIGTAIL

FUSELAGE 3/32" X 1/16"

.012 WIRE

TAIL BOOM 1/8" TAPER TO 1/16" X 1/32"

2° LEFT
THRUST

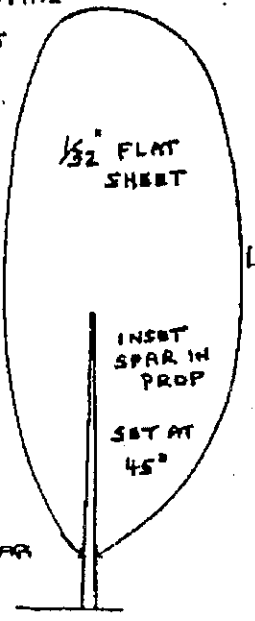

1/32" FLAT
SHEET

INSERT
SPAR IN
PROP

SET AT
45°

SPAR
3/32"
TO
1/32"

PROP SHAFT
1/32" STEEL WIRE

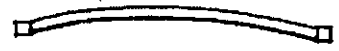
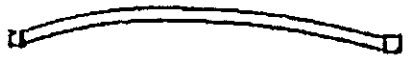

FULL SIZE RIBS - 1/32" SHEET
AND
PROP

BOOM 1/16" WIDE
OFFSET 1/2" FOR
LEFT TURN.

INTERNATIONAL A-6
JOHN LENDERMAN
JANUARY 1998

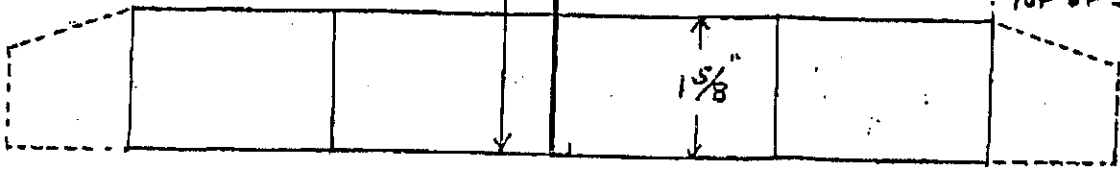

GLUE RUDDERS TO
TOP OF STAB

MODIFICATIONS TO #2:
RIBS:
3/4" WING PEGS, 045
MOUNTED ON PAPER TUBES
TAILBOOM TO 7/16"
STABILIZER - SHORTEN TO
7/16" WITH 5 RIBS
.012 WIRE PIGTAIL



HUGE SELECTION OF TOOLS, SUPPLIES AND ACCESSORIES
SAFE AND SECURE INTERNATIONAL SHIPPING
MOST ORDERS SHIP WITHIN 1 BUSINESS DAY

3955 S. Mariposa St.
Englewood, CO 80110
Phone: 720-833-9300
Toll Free: 877-754-7465
www.A2ZCorp.us/store



Sting 42 Discus Launch
 Competition Glider.
 Includes carbon boom,
 laser cut contest wood,
 Smoothie MKIII timer.
 Upgraded & AMA legal
 item code: STA013



Propellers
 Classic silver Peck
 props 4" - 9 1/2"
 Ikara indoor props.



Needle Cap Bottles
 Save your health & kicker
 20 and 25 ga blunt needle
 1/4 & 1/2 oz bottles
 Great for solvents & oil



One Nite 28
 Contest Balsa & Laser Cut.
 A quick building P30 & sport flying
 outdoor duration plane
 item code: PP013-L



McLeod Balsa Stripper
 Perfect for outdoor FF
 & RC builders.
 Cuts to 1/4" x 3/4"
 item code: BSDM1



Phantom Flash
 Build for rubber FF or micro RC.
 Contest Balsa & Laser Cut.
 item code: PP045-L



Ambroid Cement
 Classic glue for building
 light & strong.
 Tubes, pints, and quarts.



Pietenpol Air Camper
 A popular 1931 papasol homebuill.
 Contest Balsa & Laser Cut.
 item code: PP001-L



Peck Contest Balsa
 Individually weighed sheets.
 Sold in 1 lbs ranges, 4, 5, 6, 7,
 8lbs/cu ft. Grain categories A/B or C.

Nesmith Cougar
 Held the world's record
 in peanut scale.
 Contest Balsa & Laser Cut.
 item code: PP007-L

OVER 300 MODEL KITS IN STOCK!

For fastest service order online at
www.A2ZCorp.us/store

Downloadable catalog & price list with over 1000 items.
 Free flight, Indoor, and Micro Plane items available online.

Divisions Include:

STING AERO PRODUCTS

Peck-Polymers

Indoor Model Supply



Indoor Model Specialties

High quality, Low prices

Tools from Scales to Rubber Strippers
 Material from Ultrafilm to Thrust Bearings
 Bambino competitive Science Olympiad model kit

See my brochure under Links at
<http://www.indoorduration.com>

Ray Harlan
 15 Happy Hollow Road
 Wayland, MA 01778
 508.358.4013

Mastercard and Visa accepted





Ray wants to add this to his ad for Indoor Specialties, so here it is.

Specialty tools, including Scales, Rubber and Balsa Strippers, Tail boom forms, Dial gages, Boron glue Applicators, And Top Hat Benders.

Materials, including, Ultra and Superultra Pigtail thrust Bearings, Bracing Wire, Boron (.003 and .004), O Rings, Condenser Paper.

Buy online at www.indoorspecialties.com Also on the website: articles on building and trimming. Credit cards and PayPal accepted

NATIONAL FREE FLIGHT SOCIETY

Contact: Gene Ulm
703/981-2651
geneulm@pos.org

Not a member of NFFS--The National Free Flight Society?

Announcing a *Special* offer for new members: two years for half price!

Free flighter Roy Hanson has made a generous offer: He thinks so much of the NFFS and the its publication, the NFFS *Free Flight Digest* he is paying out of his own pocket HALF the cost of EVERY NEW member who signs up for two years. \$29 dollars gets you two years if you are 19 or older ; \$9 dollars if you are younger. Non-U.S. members pay just \$37.50 for two years.

Each *Digest* issue is at least 40 pages, delivered six times a year. Each issue crammed with Free Flight how-to, plans, contest reports, photography and much more. *Digest* covers every aspect of Free Flight: AMA, Indoor, FAI, FAC, SAM, Nostalgia--the works.

If you are a former member who has let their membership lapse for a year or more, now is your chance to re-up for half price. To make it easy, you can even hit the following link and use your credit card.

<http://www.freeflight.org/JLF/MembershipOffer.htm>

Founded in 1967 to "preserve, enhance and promote the art, sport and hobby of Free Flight model aviation in all its forms", the non-profit 501(c)3 National Free Flight Society is the largest Free Flight advocacy group in the world. For more than forty years NFFS has been serving Free Flighters through various charitable programs. NFFS stages the AMA Nationals, publishes the annual NFFS Symposium Reports, and disburses tens of thousands of dollars in scholarships to deserving youth. For more information on NFFS and its programs visit www.freeflight.org.

###

INDOOR

NEWS and VIEWS

ABRAM VAN DOVER, EDITOR
112 TILLERSON DR
NEWPORT NEWS, VA
23602-4011

ISSUE # 127
WINTER 2011

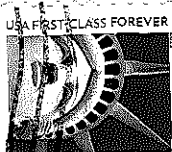

FIRST CLASS

INAV

Indoor News and Views

Yes!

Sign me up for ___ 1 year @ \$15.00 U.S., \$19.00 Canada

___ 2 years @ \$30.00 U.S., \$38.00 Canada

___ Archive CD @ \$45.00 U.S., \$3.00 Shipping

Name _____

Address _____

City _____ State _____ Zip _____

Send a Sample Copy to a Friend???

Friend's Name _____

Address _____

City _____ State _____ Zip _____

Send all dues to: Abram Van Dover
112 Tillerson Dr
Newport News, VA
23602

Please make all checks out
To: Abram Van Dover

112 TILLERSON DRIVE
NEWPORT NEWS, VA 23602-4011